



STANFORD RESEARCH INSTITUTE
 Menlo Park, California 94025 • U.S.A.

Final Report

Covering the Period January 1974 through February 1975

PERCEPTUAL AUGMENTATION TECHNIQUES

Part One--Executive Summary

By: Harold E. Puthoff and Russell Targ
Electronics and Bioengineering Laboratory

SRI Project 3183

Approved by:

Earle Jones, Director
Electronics and Bioengineering Laboratory

Bonnar Cox, Executive Director
Information Science and Engineering Division

CLASSIFIED BY **027555**
 EXEMPT FROM GENERAL DECLASSIFICATION
 SCHEDULES OF E.O. 13526, EXEMPTION CATEGORY
 1, BY **027555** ON **04/15/2009** OR EARLIER
 AUTOMATICALLY DECLASSIFIED ON
Impossible to determine
 (UNLESS IMPOSSIBLE, INSERT DATE OR EVENT)

~~INTERNATIONAL SECURITY INFORMATION~~
~~Unauthorized Disclosure Subject to~~
~~Criminal Sanctions.~~

Approved For Release
 Date **1/4/14** **1885**

~~SECRET~~

RELEASED **FEB 97**

20

UNCLASSIFIED

1 OBJECTIVE

The goal of this program was to determine the extent to which certain individuals obtain accurate information about their environment under conditions thought to be secure against such access and without the use of known human perceptual modalities.

The program was divided into two categories of approximately equal ~~effort--applied--research--and--basic--research.~~ ~~The--applied--research--effort~~ explored the operational utility of the above perceptual abilities. The basic research effort was directed toward identification of the characteristics of individuals possessing such abilities and the determination of neurophysiological correlates and basic mechanisms involved in such functioning.

UNCLASSIFIED

UNCLASSIFIED

II SUMMARY

As a result of exploratory research on human perception carried out in SRI's Electronics and Bioengineering Laboratory, we observed the emergence of a perceptual channel whereby certain individuals access and describe, by means of mental imagery, randomly-chosen remote sites located several miles or more away. In this final report, we document the study at SRI of this human information-accessing capability which we call "remote viewing," the characteristics of which appear to fall outside the range of well-understood perceptual/information-processing abilities. This phenomenon pertains to the ability of certain individuals to access and describe, by means of internal mental processes, information sources blocked from ordinary perception and generally accepted as secure against such access. These individuals include not only SRI subjects, but visiting staff members of the sponsoring organization who participated as subjects in order to critique the protocol. Experiments carried out under controlled laboratory conditions included the reproduction of line drawings shielded against ordinary perception, the determination of the electronic state of a four-state random number generator, and the viewing of remote geographical locations, all at levels of statistical significance $p < 10^{-6}$. Our initial work in this area has been reported in the open literature under the title "Information Transmission Under Conditions of Sensory Shielding," Nature 252, 15 October 1974, and reprinted in the IEEE Communications 13, January 1975. A copy of this publication is included as Appendix A of this report.

Since our initial work the phenomenon we have investigated most

extensively is the ability of individuals to view remote geographical locations (up to several thousand kilometers), given only coordinates (latitude and longitude) of a person on whom to target. We have worked with a number of individuals, including sponsor personnel, whose remote perceptual abilities have been developed sufficiently to allow them at times to describe correctly--often in great detail--geographical or technical material such as buildings, roads, laboratory apparatus, and the like.

The development of this capability at SRI has evolved to the point where (a) visiting CIA personnel with no previous exposure to such concepts have performed well under controlled laboratory conditions (that is, generated target descriptions of sufficiently high quality to permit blind matching of descriptions to targets by independent judges), and (b) subjects trained over a one-year period have performed well under operational conditions (that is, provided data of operational significance later verified by independent sources). Our accumulated data thus indicate that both specially selected and unselected persons can be assisted in developing remote perceptual abilities to a level of useful information transfer.

To indicate the level of proficiency that can be reached, we present four examples generated by experienced subjects. The first category consists of long-distance (trans-Atlantic) remote-viewing of a large-scale installation. The second category consists of two or more subjects remote-viewing the same target, independently, which in this series was technical apparatus. The third category consists of remote sensing of the internal sea of a piece of electronic equipment. The fourth category consists of the perturbation of remote equipment.

A. Category I: Long-Distance Remote Viewing

In order to subject the remote viewing phenomena to a rigorous long-distance test under external control, a request for geographical coordinates of a site unknown to subject and experimenters was forwarded to the OSI group responsible for threat analysis in this area. In response, SRI personnel received a set of geographical coordinates (latitude and longitude in degrees, minutes, and seconds) of a facility, hereafter referred to as the West Virginia Site. The experimenters then carried out a remote viewing experiment on a double-blind basis, that is, blind to experimenters as well as subject. The experiment had as its goal the determination of the utility of remote viewing under conditions approximating an operational scenario. Two subjects targeted on the site, a sensitive installation. One subject drew a detailed map of the building and grounds layout, the other provided information about the interior including codewords, data subsequently verified by sponsor sources (report available from COTR).

A long-distance remote viewing experiment was then carried out on a sponsor-designated target of interest, a research center at Semipalatinsk, USSR. The Contracting Officer Technical Representative (COTR) furnished map coordinates to the experimenters. The only additional information provided was the designation of the target as an R&D test facility. The experimenters then carried out a remote viewing experiment on a double-blind basis with a subject (SI)^a trained in the SRI program. Figure 1(a) shows the subject's graphic effort for building layout; Figure 1(b) shows the subject's particular attention to a multistory gantry crane he observed at the site. (Again, these results were obtained on a double-blind basis

^a A key to numerical designations for subjects is available from the COTR.

A. Category I: Long-Distance Remote Viewing

In order to subject the remote viewing phenomena to a rigorous long-distance test under external control, a request for geographical coordinates of a site unknown to subject and experimenters was forwarded to the OSI group responsible for threat analysis in this area. In response, SRI personnel received a set of geographical coordinates (latitude and longitude in degrees, minutes, and seconds) of a facility, hereafter referred to as the West Virginia Site. The experimenters then carried out a remote viewing experiment on a double-blind basis, that is, blind to experimenters as well as subject. The experiment had as its goal the determination of the utility of remote viewing under conditions approximating an operational scenario. Two subjects targeted on the site, a sensitive installation. One subject drew a detailed map of the building and grounds layout, the other provided information about the interior including codewords, data subsequently verified by sponsor sources (report available from COTR).

A long-distance remote viewing experiment was then carried out on a sponsor-designated target of interest, a research center at Semipalatinsk, USSR. The Contracting Officer Technical Representative (COTR) furnished map coordinates to the experimenters. The only additional information provided was the designation of the target as an R&D test facility. The experimenters then carried out a remote viewing experiment on a double-blind basis with a subject (SI)* trained in the SRI program. Figure 1(a) shows the subject's graphic effort for building layout; Figure 1(b) shows the subject's particular attention to a multistory gantry crane he observed at the site. (Again, these results were obtained on a double-blind basis

* A key to numerical designations for subjects is available from the COTR.

UNCLASSIFIED

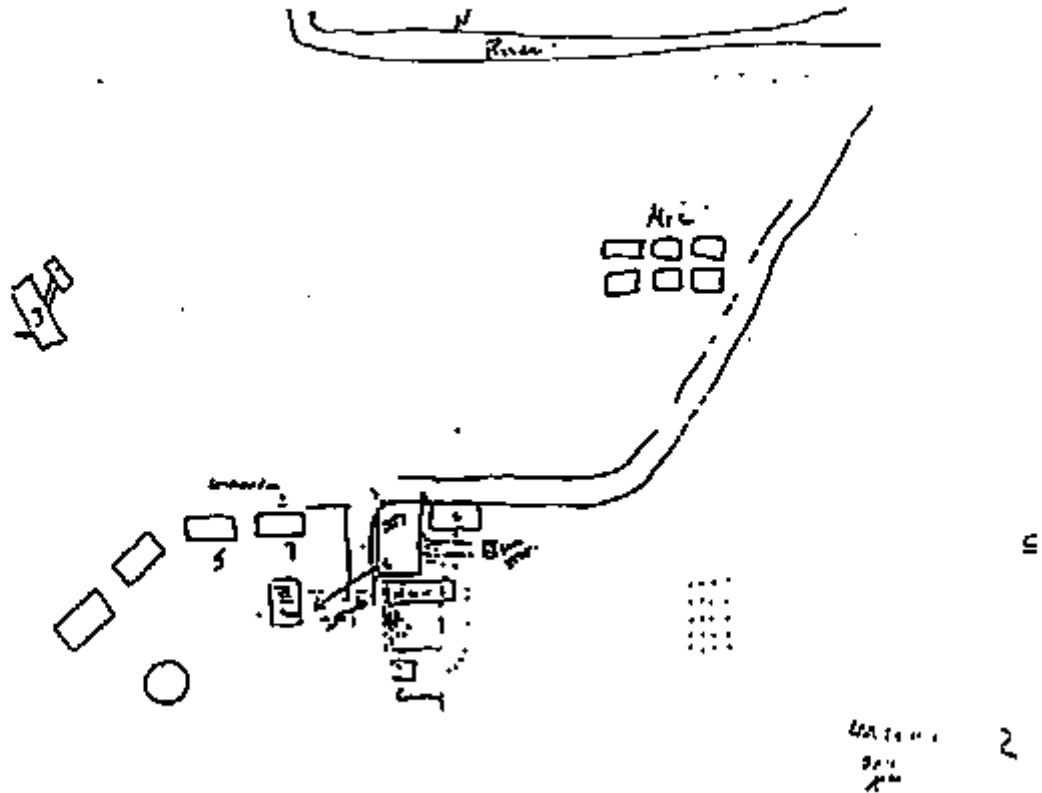

(a) SUBJECT EFFORT AT BUILDING LAYOUT

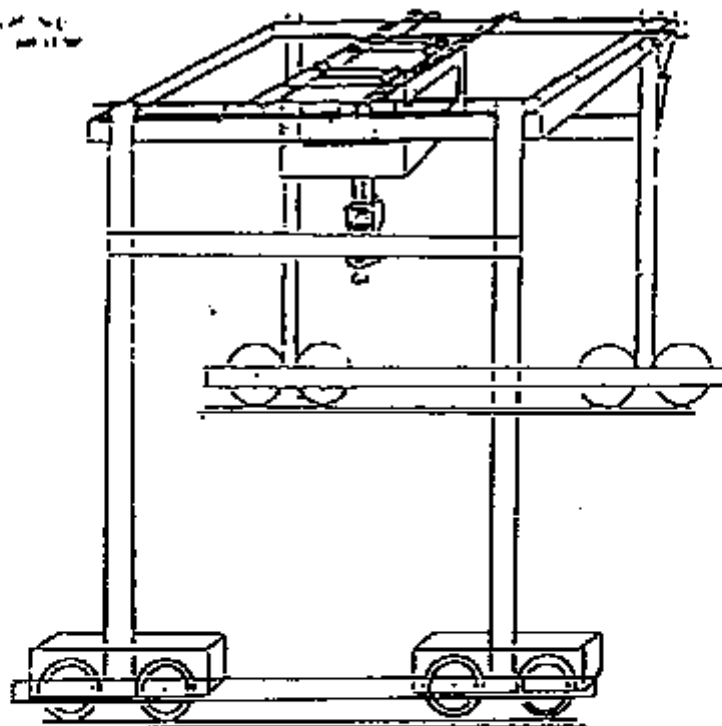

(b) SUBJECT EFFORT AT CRANE CONSTRUCTION

FIGURE 1

UNCLASSIFIED

before exposure to the COIR-held information, thus eliminating the possibility of cueing.) For comparison an artist's rendering of the site as known to the COIR (but not to contract personnel) is shown in Figure 2(a), with crane detail shown in Figure 2(b). The exceptionally accurate description of the multistory crane was taken as indicative of probable target acquisition, and therefore the subject was introduced to sponsor personnel who collected further data for evaluation. The latter contained both additional physical data which were independently verified by other sponsor resources, thus providing additional calibration, and also initially-unverifiable data of current operational interest. Several hours of tape transcript and a notebook full of drawings were generated over a two-week period. A description of the data and evaluation is contained in a separate report. The results contained noise along with the signal, but were nonetheless clearly differentiated from the chance results generated by control subjects in comparison experiments carried out by the COIR.

3. Category II: Technology Series (Multiple)

A series of experiments designed to measure the resolution capability of the remote viewing phenomenon were carried out within the confines of SRI. In each experiment a subject was asked to attempt to describe remote laboratory equipment, demarcated only by a target individual sent to a location of interest by means of a random protocol outside the experimenters' control. The experimenter remaining with the subject was kept ignorant of the contents of the target pool to prevent cueing during questioning. The subject was asked to describe the apparatus both verbally (tape recorded) and by means of drawings. The sample presented here is not an edited collection of "best ever" results, but rather consists of the results of the entire collection of experiments directly involving visiting CIA personnel in which

~~SECRET~~

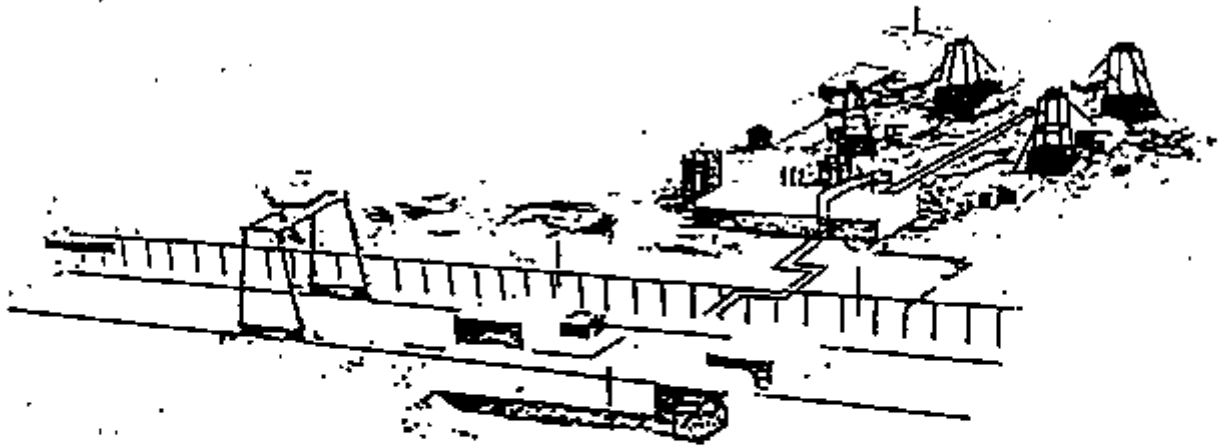

(a) TARGET SITE

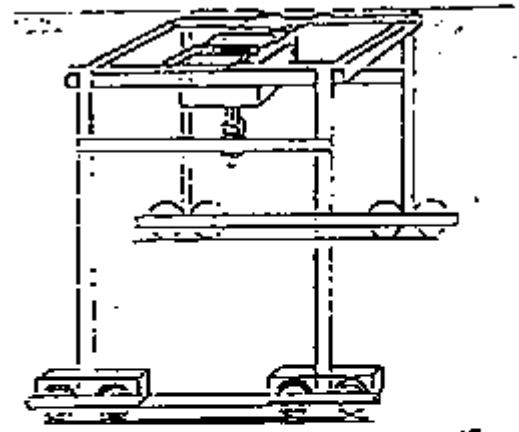
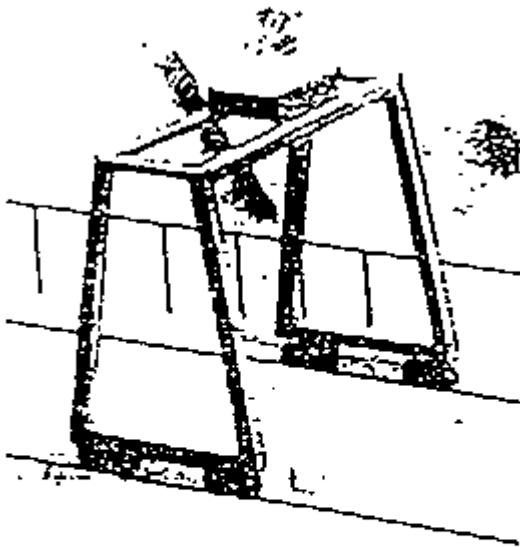

(b) CRANE COMPARISON

FIGURE 2

~~SECRET~~

two or more subjects independently viewed an identical technological target.

The target for Experiment 1, a typewriter, was chosen by a sponsor staff member during a site visit. The response drawn by the subject (S4), located approximately 100 yards away, is shown on the right of Figure 3. The target was re-used at a later date with another subject, resulting in the response on the left.

The target for Experiment 2 was a Xerox machine, chosen by the COTR during a site visit. In response the drawing on the right of Figure 4 was generated by a second sponsor staff member who agreed to participate as a subject in this one experiment in order to evaluate the protocol. The target was re-used at a later date with an SRI subject (S2) in an experiment under observation by sponsor personnel, resulting in the response on the left. Finally, the same target came up for subject S3 during a random technological target series, resulting in the drawing in the center.

The target for Experiment 3, a computer input-output unit, resulted in the responses shown in Figure 5. The response on the left was generated by SRI subject S4, the one on the right by a visiting sponsor staff member who participated as a subject in a random technological target series.

Such results, generated in experiments with viewing windows of 15-min. duration, indicate the presence of an information channel of useful bit rate. Furthermore, it would appear that by correlating a number of subject responses to a given target, we can obtain enhancement of the signal-to-noise ratio.

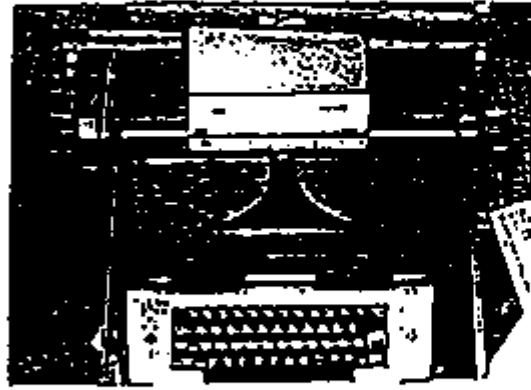
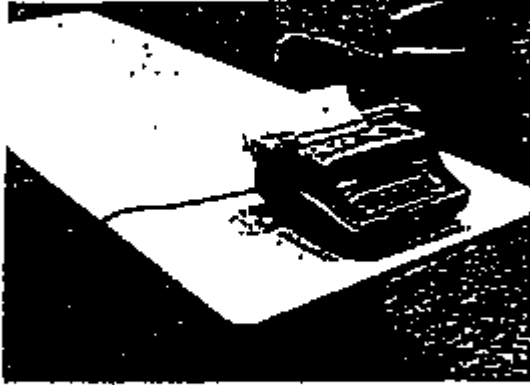

TECHNOLOGY SERIES
TYPEWRITER TARGET

Factor 2, number 1, 2 parts
one sitting on top of the other -
a machine in 2 parts -
white on the side
and the floor was a bridge

11.23

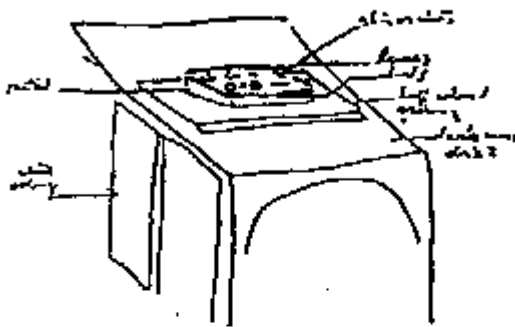

the light and black
a square corner

SRI SUBJECT S3 RESPONSE

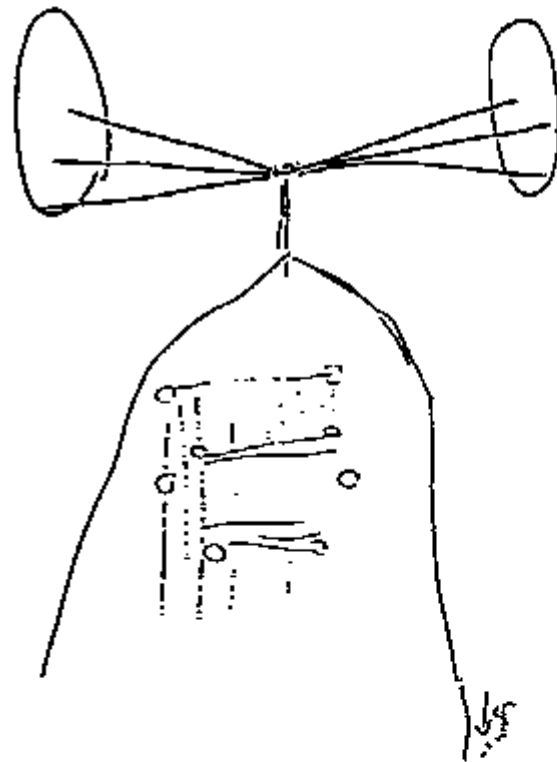

SRI SUBJECT S4 RESPONSE

TA-760522-76

FIGURE 3 DRAWINGS BY TWO SUBJECTS OF A TYPEWRITER TARGET



TARGET LOCATION; XEROX MACHINE
(TECHNOLOGY SERIES)



EXPERIMENTER WITH HIS
HEAD BEING XEROXED
(TO ADD INTEREST TO
TARGET LOCATION)

U



SRI SUBJECT S2 RESPONSE

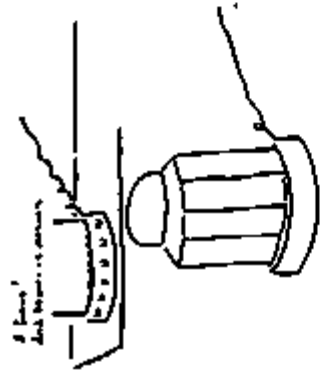

SRI SUBJECT S3 RESPONSE

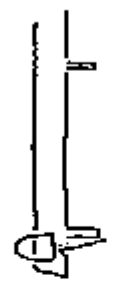

SRI SUBJECT S1 RESPONSE



SPONSOR SUBJECT RESPONSE

When asked to describe the square at upper left, the subject said, "There was this pre-dominant light source which might have been a window, and a working surface which might have been the sill, or a working surface or desk." Earlier the subject had said, "I have the feeling that there is something silhouetted against the window."

TA-760527-7A

FIGURE 4 DRAWINGS BY THREE SUBJECTS FOR XEROX MACHINE TARGET

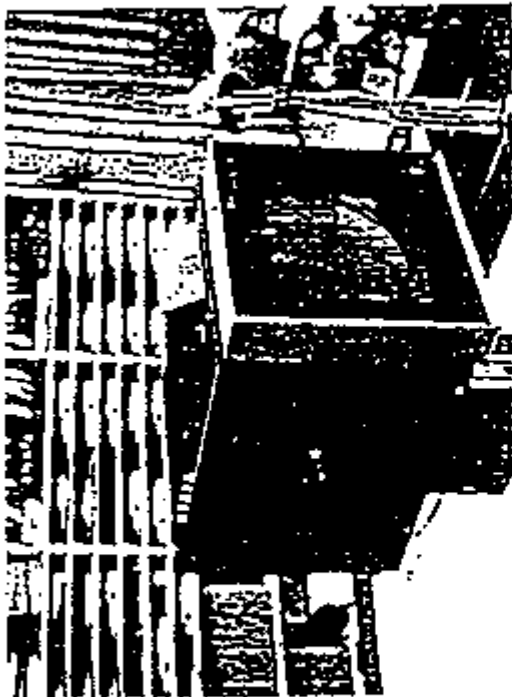
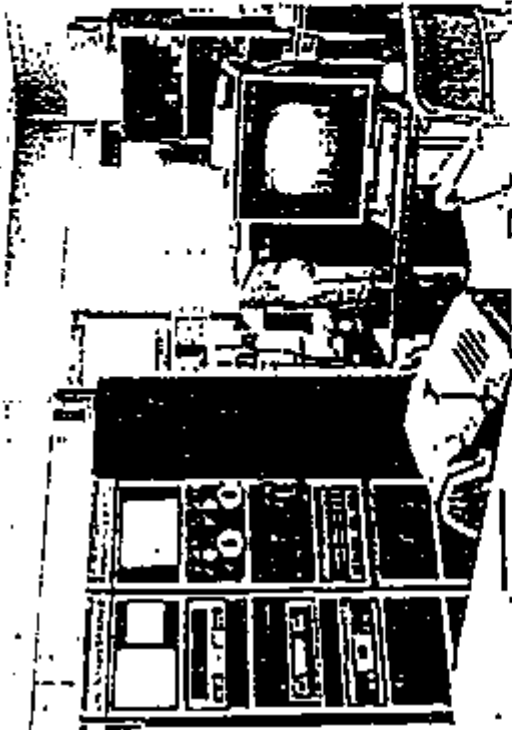

TARGET: VIDEO MONITOR FOR TEXT EDITING (TECHNOLOGY SERIES)

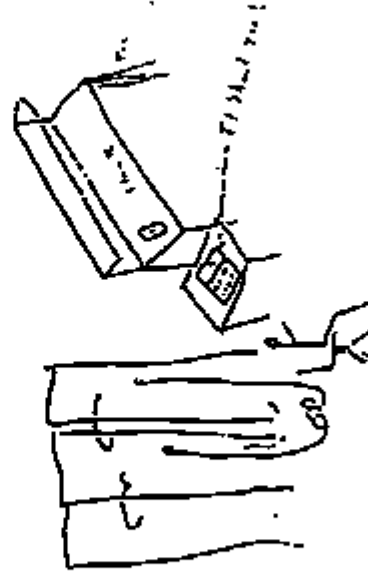

SECOND SUBJECT SAW A TEXAS INSTRUMENTS
"SILENT 700" COMPUTER TERMINAL
SPONSOR SUBJECT RESPONSE
DA-2102-B

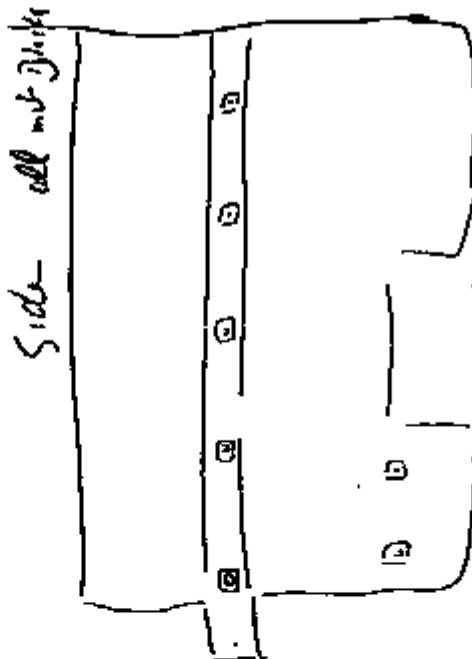

SUBJECT DRAWING OF "BOX WITH LIGHT COMING OUT OF IT . . . PAINTED
FLAT BLACK AND IN THE MIDDLE OF THE ROOM"
SRI SUBJECT S4 RESPONSE

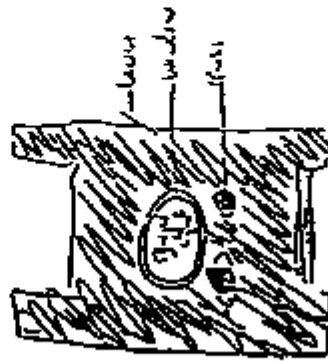

FIGURE 5 DRAWING BY TWO SUBJECTS OF A VIDEO MONITOR TARGET

C. Category III: Remote Sensing of Internal States of Electronic Equipment

To determine whether remote viewing could be extended beyond visual perception to the sensing of the internal state of a piece of electronic equipment, further experimentation was carried out with six subjects who had shown an ability in remote viewing. The task was the determination of the internal electronic state of a four-state random number generator ($p = 1/4$ for each of four equal-probability outputs) whose characteristics had been examined in detail to verify its randomness. The solid-state machine has no moving parts and provides no sensory cue to the user as to its current generation. (See Figure 6.) Although the task appeared more difficult, one of six subjects consistently scored significantly better than chance ($p = 3 \times 10^{-7}$). In the required 2500-trial run the latter obtained 17.4% more hits (734) than would be expected by chance (625). When the subject was asked to repeat the entire experiment at a later time, he was able to replicate successfully a high scoring rate (11.5% more hits than expected by chance, $p = 4.8 \times 10^{-6}$).

UNCLASSIFIED

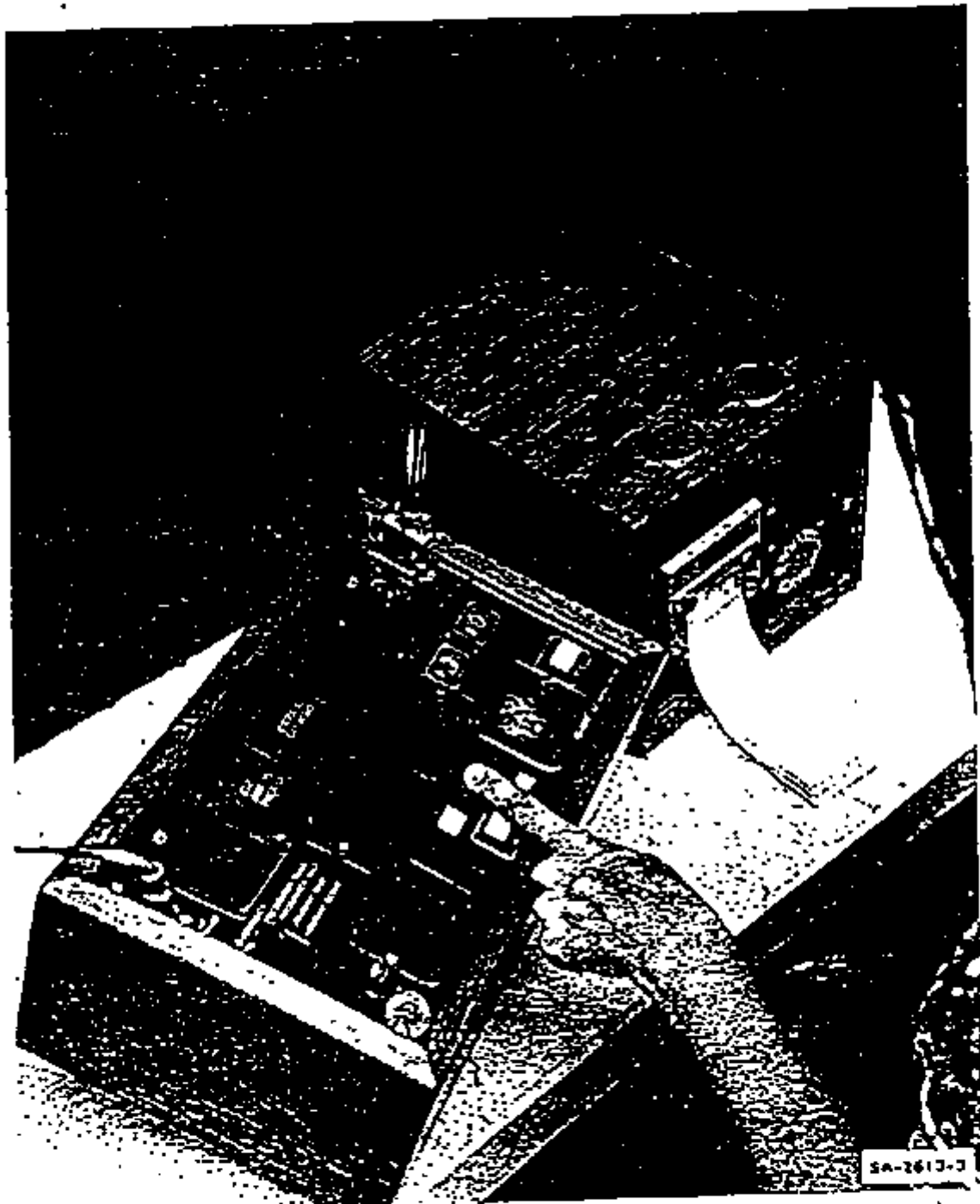

FIGURE 6 FOUR-STATE RANDOM NUMBER GENERATOR

The printer to the right of the machine records data automatically on fan-fold paper tape.

UNCLASSIFIED

D. Category IV: Perturbation of Remote Equipment

Additional experimentation was initiated to investigate the possibility that the remote sensing channel may possess bilateral aspects; for example, it might be possible to couple energy from an individual to a remote location as well as in reverse. To test this hypothesis, experiments were carried out with a sensitive magnetometer in an adjoining laboratory as the remote target. Use of an ORD-developed magnetometer was arranged by ORD personnel. In a series of thirteen 10-trial runs with 50 seconds per trial, perturbations of the magnetometer by a subject gifted in remote viewing were obtained under a strict randomization protocol, yielding a positive result significant at the $p = 0.004$ level. Because of the potential significance and implications of such findings, we intend to collect considerable additional data before arriving at a hard conclusion. Nonetheless, as a tentative conclusion there is evidence that a piece of sensitive equipment can be perturbed by a subject during remote viewing, thus implying that the information channel under investigation may sustain energy transfer in either direction.

E. General Considerations

The primary achievement of the SRI program was the elicitation of high quality remote viewing by individuals who agreed to act as subjects. Criticism of this claim could in principle be put forward on the basis of three potential flaws: (1) the study could involve naivete in protocol which permits various forms of cueing, intentional or unincidental; (2) the experiments discussed could be selected out of a larger pool of experiments of which many are of poorer quality; (3) data for the reported experiments could be edited to show only the matching elements, the non-matching

elements being discarded.

All three criticisms, however, are invalid. First, with regard to cueing, the use of double-blind protocols ensures that no person in contact with the subject can be aware of the target. Second, no selection of experiments for reporting takes place; every experiment is entered as performed on a master log and is included in the statistical evaluations. Third, data associated with a given experiment remain unedited; all data associated with an experiment are tape recorded and included unedited in the data package to be judged, evaluated, etc. Finally, the entire unedited file of tape recordings, transcripts and drawings for every experiment is available to the COTR and others in the scientific community for independent analysis.

The observed results outlined in A through D above (target acquisition, equipment description, electronic state specification, and perturbation of instrument operation) may together constitute different aspects of a single remote coupling phenomenon. With regard to understanding the phenomenon itself, the precise nature of the information channel coupling remote locations is not yet understood. However, we can show that its characteristics are compatible with both quantum theory and information theory and with recent developments in research on brain function. Therefore, our working assumption is that the phenomenon of interest does not lie outside the purview of modern physics and with further work will yield to analysis and specification.

Further, with an eye toward future subject selection, subjects possessing a well-developed natural ability in the area under consideration underwent complete physical, psychological, and neuropsychological profiling, the results of which suggest the core of a screening procedure.

UNCLASSIFIED

Finally, it is concluded by the research contractors that the accrual of experience in three years of successful effort constitutes an asset that could be utilized in the future both for operational needs and for training others in the development and use of the remote sensing capability.